











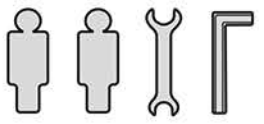

A M A Z O N A S

SIENA DUE

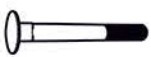

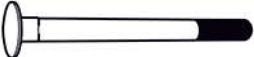
 OFFICE FOR HARMONIZATION
 IN THE INTERNAL MARKET
 (TRADE MARKS AND DESIGNS)



- a(6x50mm) x8  b(8x60mm) x2  c(8x80mm) x2 
- d(6x45mm) x4  e(6x80mm) x3  f(8x90mm) x6 
- g x7  h x8  i x7  j x10 

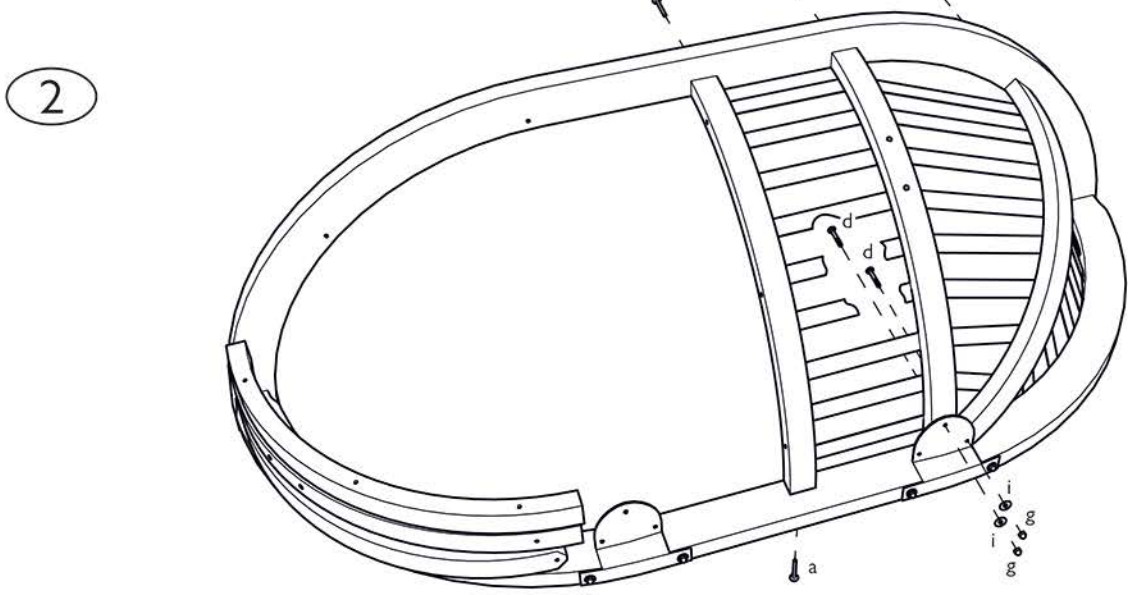
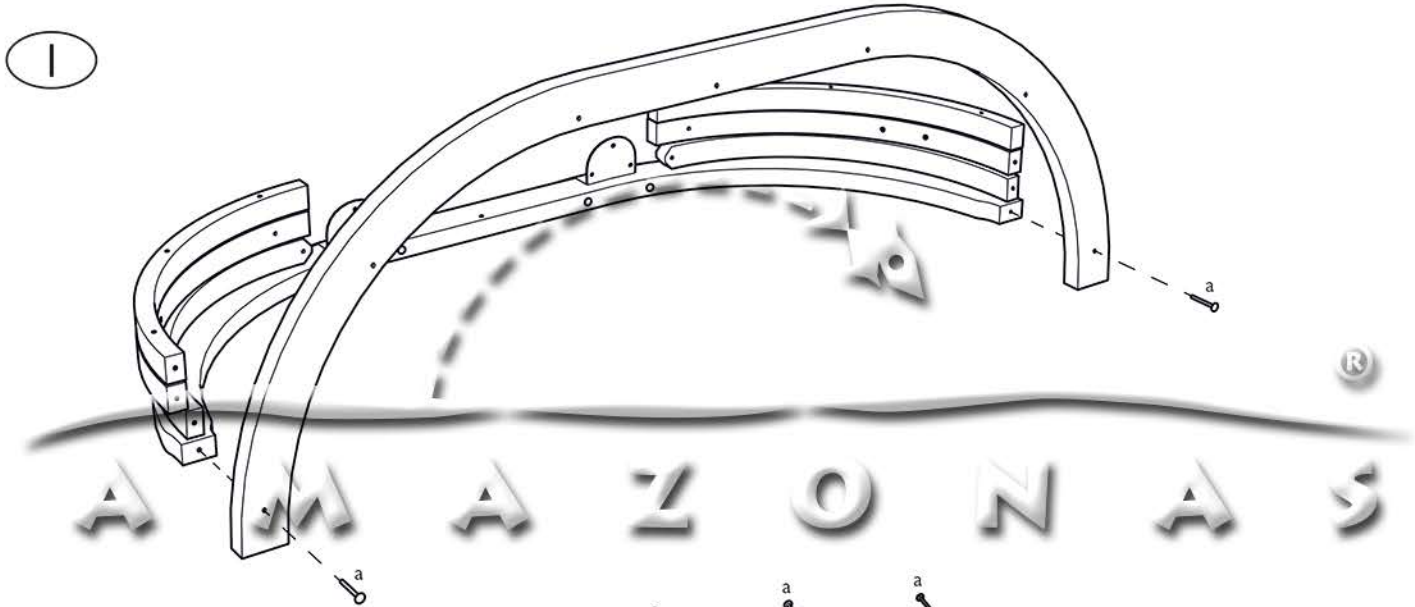

AMAZONAS GMBH
AM KIRCHENHÖLZL 15
D-82 166 GRÄFELFING, GERMANY
WWW.AMAZONAS.EU

max. 250 kg

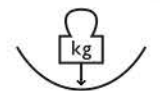

Stand: 28.09.2015

